

### METAL FINISH



101 White



103 Anthracite



104 Taupe



117 Wenge

\* Powder Coated(mat)  
strengthened against rusting  
and scratches with cataphoresis  
application.

### MESH FINISH

50070

05700

05374

### FABRIC FINISH (Batyline Eden)



00566  
L. Grey



00563  
Beige



00555  
Anthracite

### Net weight

25 kg

### Gross Weight

27.50 kg

### Packaging

840x940x610 / m<sup>3</sup> 0.48

### Shipment Deatils

20' : 36 pcs.  
40' : 84 pcs.  
40HC : 112 pcs.  
100cbm : 128 pcs.

### Description

BREEZE seating group is formed for outdoors by the combination of cataphoresis electrostatic powder painted metal body and puffy cushions. This collection has leading role for creating simple, serene and pleasant spaces. The concepts of comfort, design and simplicity were meticulously handled in the BREEZE collection, where carefully selected fabrics were brought together in convenient sizes.

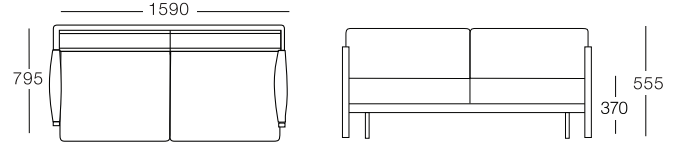

### METAL FINISH



101 White



103 Anthracite



104 Taupe



117 Wenge

\* Powder Coated(mat)  
strengthened against rusting  
and scratches with cataphoresis  
application.

### MESH FINISH

50070

05700

05374

### FABRIC FINISH (Batyline Eden)



00566  
L. Grey



00563  
Beige



00555  
Anthracite

Net weight

(kg)  
42

Gross Weight

(kg)  
46

Packaging

1  
840x1640x610 / m<sup>3</sup> 0.84

Shipment Deatils

20' : 18 pcs.  
40' : 42 pcs.  
40HC : 56 pcs.  
100cbm : 64 pcs.

### Description

BREEZE seating group is formed for outdoors by the combination of cataphoresis electrostatic powder painted metal body and puffy cushions. This collection has leading role for creating simple, serene and pleasant spaces. The concepts of comfort, design and simplicity were meticulously handled in the BREEZE collection, where carefully selected fabrics were brought together in convenient sizes.

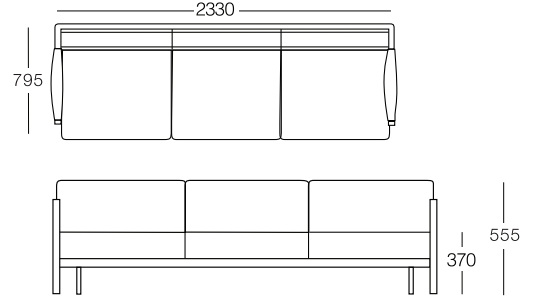

### METAL FINISH



101 White



103 Anthracite



104 Taupe



117 Wenge

\* Powder Coated(mat)  
strengthened against rusting  
and scratches with cataphoresis  
application.

### MESH FINISH

50070

05700

05374

### FABRIC FINISH (Batyline Eden)



00566  
L. Grey



00563  
Beige



00555  
Anthracite

#### Net weight

58

#### Gross Weight

63

#### Packaging

840x2380x610 / m<sup>3</sup> 1.21

#### Shipment Deatils

20' : 12 pcs.  
40' : 30 pcs.  
40HC : 40 pcs.  
100cbm: 64 pcs.

#### Description

BREEZE seating group is formed for outdoors by the combination of cataphoresis electrostatic powder painted metal body and puffy cushions. This collection has leading role for creating simple, serene and pleasant spaces. The concepts of comfort, design and simplicity were meticulously handled in the BREEZE collection, where carefully selected fabrics were brought together in convenient sizes.

### CENTER LOW TABLE 1100x600



REVERSE BEVEL EDGE

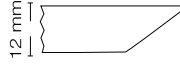

12 mm

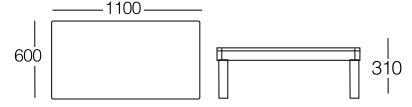

#### METAL FINISH



101 White 103 Anthracite 104 Taupe 117 Wenge

\* Powder Coated(mat)  
strengthened against rusting  
and scratches with cataphoresis  
application.

#### SOLID COMPACT FINISH (12mm)

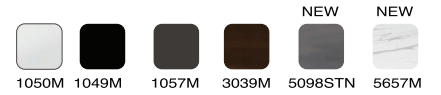

1050M 1049M 1057M 3039M 5098STN 5657M



5056M 5101STN 3120M 3169M

\*Except white, other colours are recommended only in shaded areas.

Net weight

17.70 kg

Gross Weight

20.50 kg

Packaging

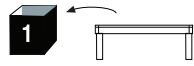

1120x620x320 / m<sup>3</sup> 0.22

Shipment Deatils



20' : 162 pcs.  
40' : 324 pcs.  
40HC : 296 pcs.  
100cbm : 504 pcs.

#### Description

With the combination of electrostatic powder painted metal leg and compact table top, BREEZE center low table has durability for outdoor. The side table is complementary item for collection. The selection can done from wide range of compact table top colour options.

### SIDE TABLE 740x740

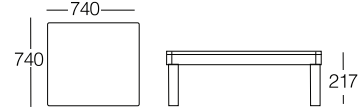
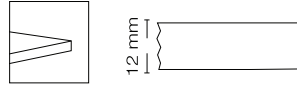

#### METAL FINISH



101 White



103 Anthracite



104 Taupe



117 Wenge

\* Powder Coated(mat)  
strengthened against rusting  
and scratches with cataphoresis  
application.

#### SOLID COMPACT FINISH (12mm)



1050M



1049M



1057M



3039M



5098STN



5657M



5056M



5101STN



3120M



3169M

\*Except white, other colours are recommended only in shaded areas.

Net weight

(kg)  
16.60

Gross Weight

(kg)  
19.00

Packaging

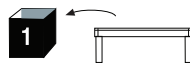

760x760x230 / m<sup>3</sup> 0.13

Shipment Deatils



20' : 189 pcs.  
40' : 405 pcs.  
40HC : 495 pcs.  
100cbm : 612 pcs.

#### Description

With the combination of electrostatic powder painted metal leg and compact table top, BREEZE side table has durability for outdoor. The side table is complementary item for collection. The selection can done from wide range of compact table top colour options.