

## OPAL WOX PRO SOFT with iroko wood leg

www.papatya.com.tr

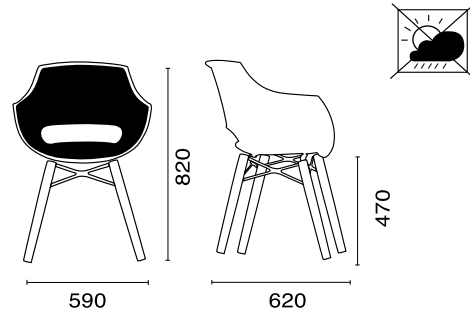

### PP FINISH

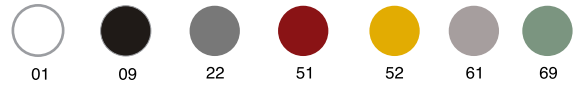

### FABRIC FINISH

Grup C / Era

Grup B / MainLine Flax - Valencia

### Frame Features ( wooden profile leg 30x30 mm )

 natural iroko wood

■ due to the nature of the iroko wood colour tone may differ.

### Metal Strap Finishes

 103 Anthracite

■ on request the strap could be produced in white (mat) finish.

For non standarts colours please check the prices and delivery time.

Net Weight

Gross Weight

Max. stacking

Assembled Package

Disassembled Package

  
6.12

  
6.89



  
610x560x840mm  
m<sup>3</sup> 0.29



20' : 102 pcs.  
40' : 212 pcs.  
40HC : 234 pcs.  
100cbm : 288 pcs.



600x565x1055mm  
m<sup>3</sup> 0.35



20' : 304 pcs.  
40' : 656 pcs.  
40HC : 788 pcs.  
100cbm : 968 pcs.

### Auxiliary Materials

4 pcs. gliders in poliasitetal - 4 pcs. metal connection part(X) - 8 pcs. connection part screws - 4 pcs. armchair montage screws.

**Iroko Wood:** Iroko is a hard tree which grows in African tropical forests and it has a very strong resistance against external influences.

**Usage and Care:** The care of Iroko products are very easy. If you want to maintain the wood's natural colour, you should treat it with teak oil. You can use sponge or brush for this application. Depending on the climate, this should be done once or twice a year. If you leave Iroko wood untreated for a long time, it will get a silver-grey colour. But this colour change, will not cause any structural deterioration. If you do not like this surface you can restore the Iroko to look like the first day you have bought it. In this case, you slightly need to sand the wood and treat with teak oil: it is up to you to decide which effect you prefer. Bear in mind however that even with an oil treatment the colour of the wood will change under the influence of UV - light and moisture. To keep the surface nice and smooth, we advise you to slightly sand the wood the every year.

Issues to be considered during the application:

- Before the application, the wood needs to be cleaned carefully with a damp cloth.
- After the oil application keep the product in a dry place and avoid sunshine & rain until it gets dry completely (minimum 2 hours)
- If you make application, we advise to use 240-300 no sandpaper.

Product Quality Certificate

---





Available for  
indoor usage



Cigarette &  
Match



CSE01 Futurist



CSE02 Generation



CSE03 Lifetime



CSE05 Span



CSE06 Cycle



CSE07 Period

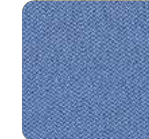

CSE08 Chapter



CSE09 Prime



CSE10 Everlasting

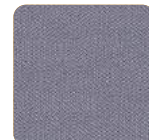

CSE11 Forecast



CSE12 Perennial



CSE13 Present



CSE14 Forward



CSE15 Stage



CSE16 Timelapse



CSE17 Phase

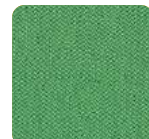

CSE18 Event

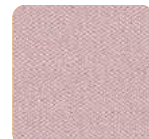

CSE19 Calender

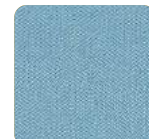

CSE20 Aeon

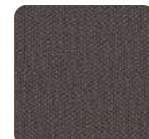

CSE21 History



CSE23 Occurrence



CSE24 Date

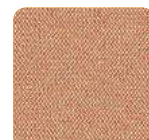

CSE25 Sequence

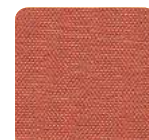

CSE26 Turn

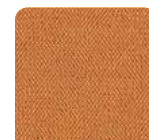

CSE27 Measure



CSE28 Extent

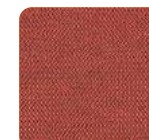

CSE29 Experince

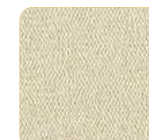

CSE30 Transition



CSE31 Splitsecond



CSE32 Occasion

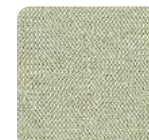

CSE33 Analogue

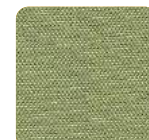

CSE34 Endurance



CSE35 Signature



CSE36 Notation



CSE37 Rest



CSE38 Allowance



CSE39 Youth

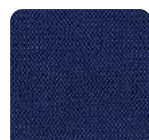

CSE40 Maturity



CSE41 Quota

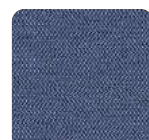

CSE42 Range



CSE43 Late



CSE44 Elapse



CSE45 Prompt



CSE46 Memo



Available for  
indoor usage



Cigarette &  
Match



Medium  
Hazard B1



MLF01 Aldgate



MLF02 Archway



MLF03 Barbican



MLF04 Euston



MLF05 Holborn



MLF06 Kilburn



MLF07 Kensington



MLF08 Lambeth



MLF09 Monument



MLF11 Wembley



MLF12 Morden



MLF13 Leyton

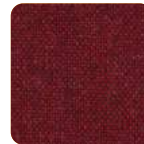

MLF14 Parsons



MLF15 Stockwell



MLF16 Temple



MLF17 Tooting



MLF18 Tufnell

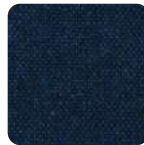

MLF19 Victoria

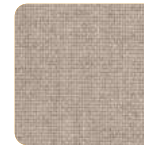

MLF20 Upminster

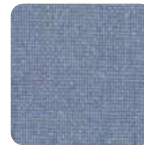

MLF21 Waterloo



MLF23 Bank



MLF24 Bayswater



MLF25 Bethnal



MLF26 Camden



MLF27 Charing

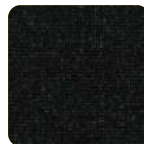

MLF28 Edgware



MLF29 Farringdon

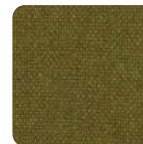

MLF30 Finsbury



MLF31 Goldhawk



MLF32 Greenford



MLF33 Highgate

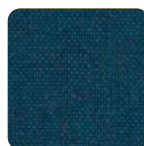

MLF34 Pimlico

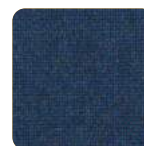

MLF35 Brompton

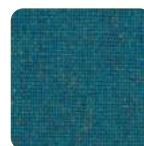

MLF37 Stanmore



MLF38 Russell



MLF39 Paddington



MLF40 Northfields

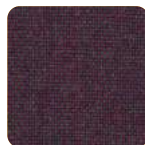

MLF41 Hillingdon





Available for  
Indoor



Marine  
usage



Citrus



Night



Avocado



Squash



Tomato

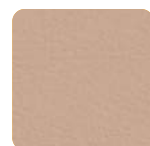

Lotus



Rose



Chestnut



Camel

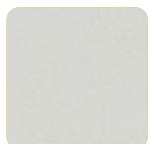

Pure White



Cashmere



Ultra Violet

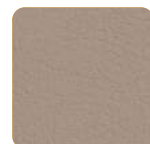

Warm Grey



Petrol

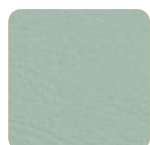

Coral



Skylight



Teal



Safran



Melone



Orange



Terracotta



Sonne



Buche



Praline



Bronze

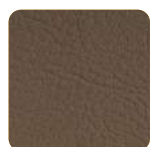

Taupe



Belge



Leinen

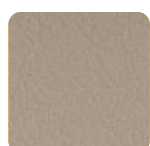

Sisal



Weiss



Auster



Perle



Platin

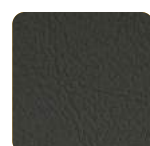

Lichtgrau



Graphite

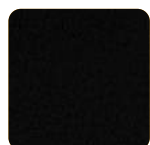

Schwarz



Laurel



Meteor



Mocca



Port



Kirsche



Rot



Pink



Berry



Amthyst



Titan



Lavendel



Baltic



Delft

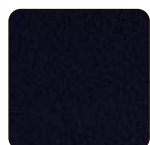

Marine



Türkis



Jade



Apfel



Olive

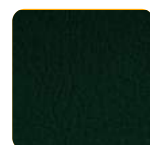

Grün



Silver

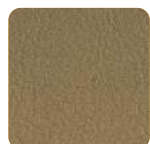

Gold



Ivory

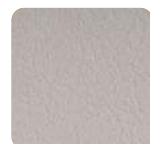

Pearlescence